

A

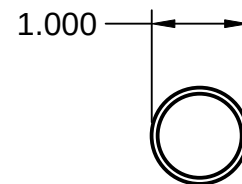

B

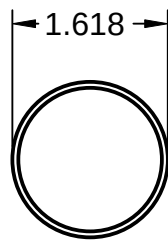

C

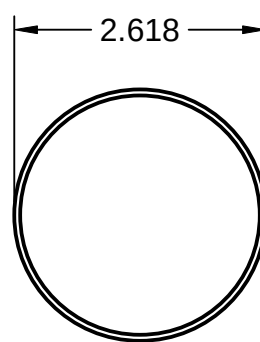

D

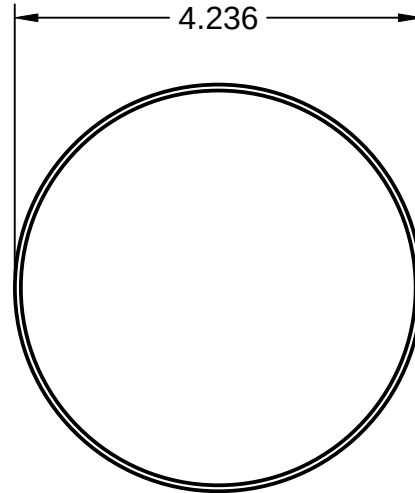

E

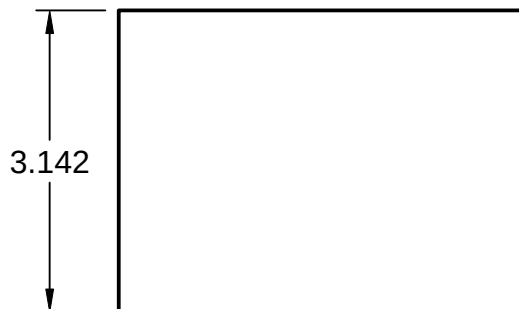
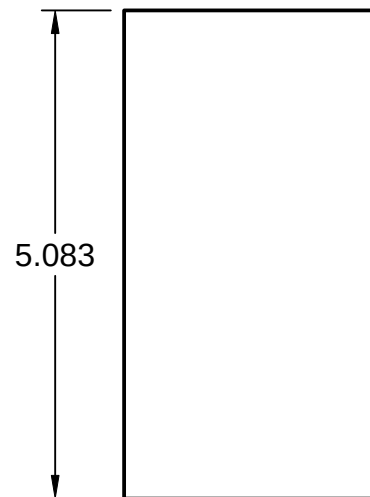
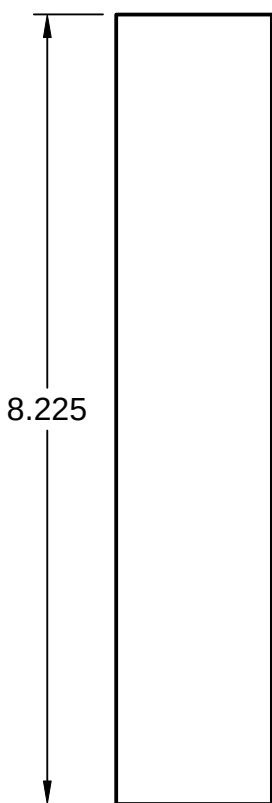
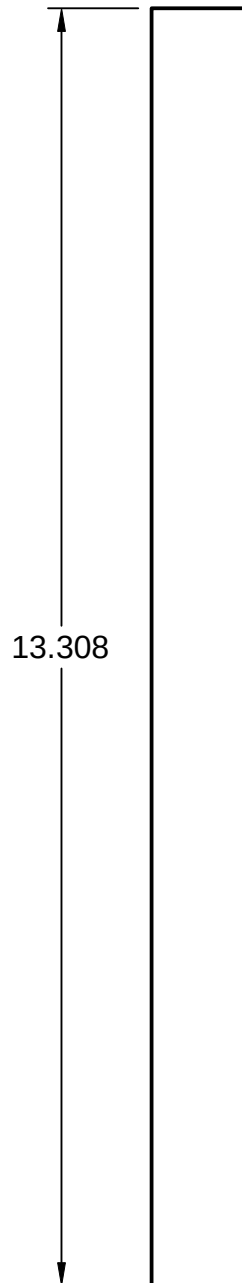
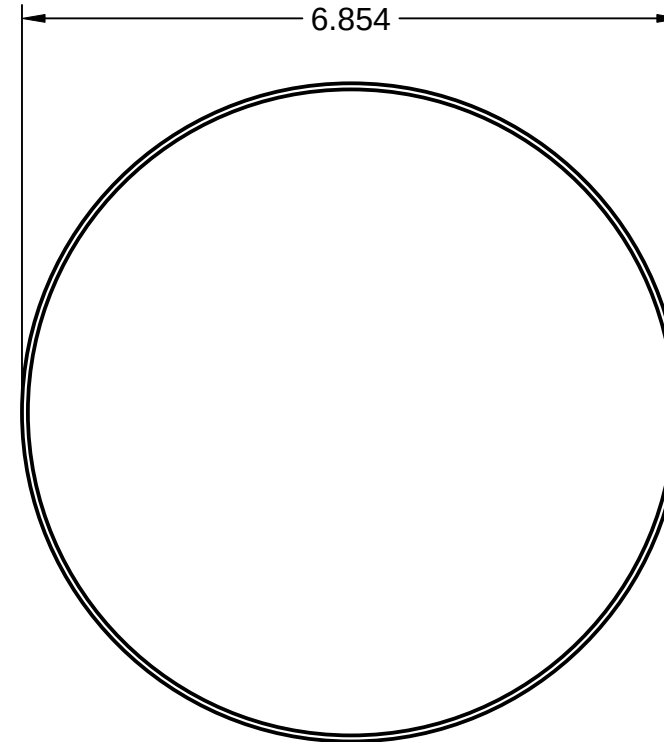

All Units in Inches

PROJECT

Wave Articulation Matrix

TITLE

1" Diameter Primary
Parts

SCALE 1:2

SHEET 1/3

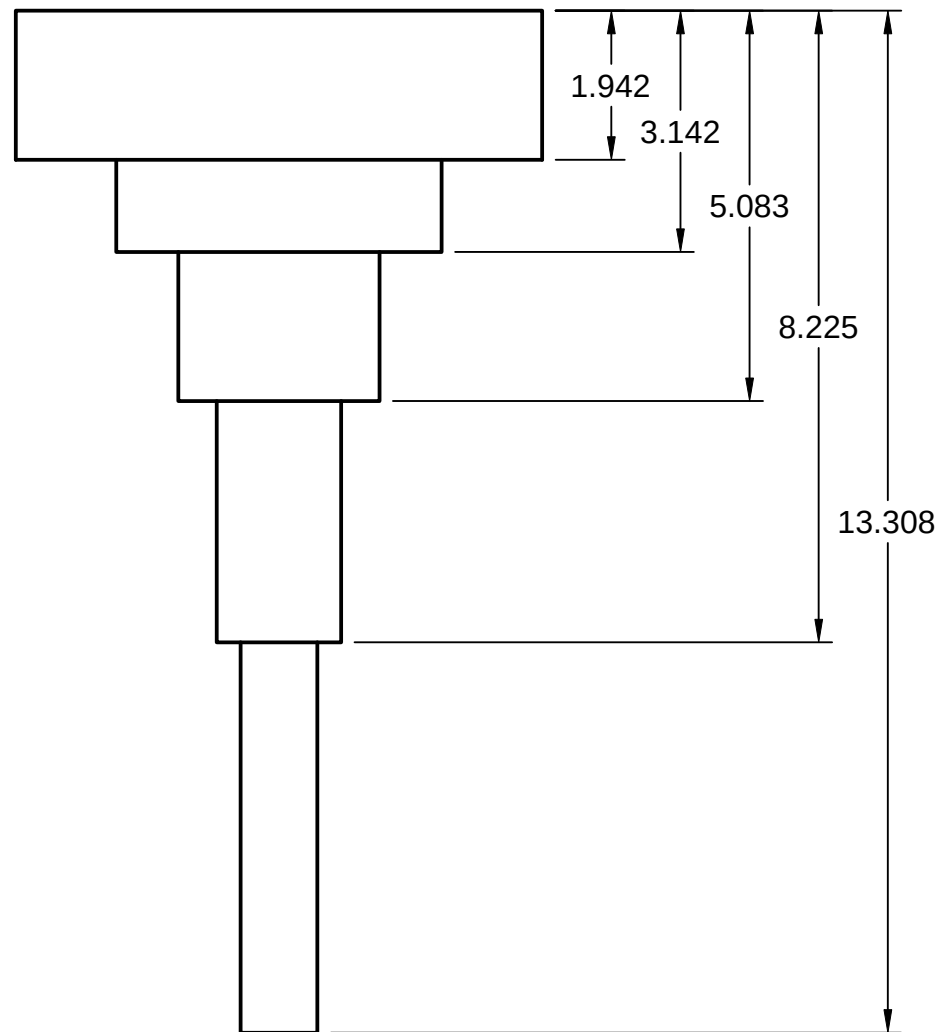
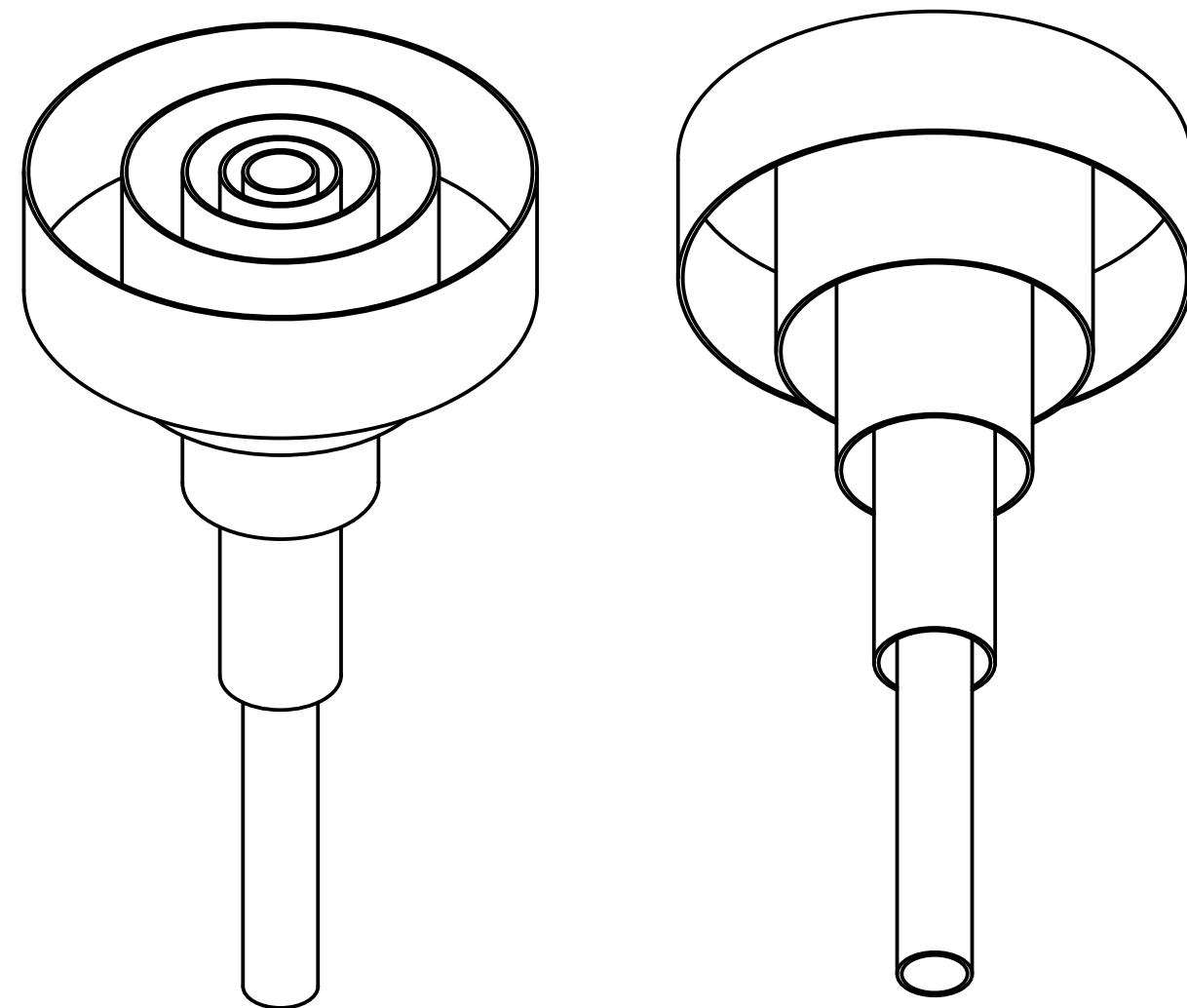
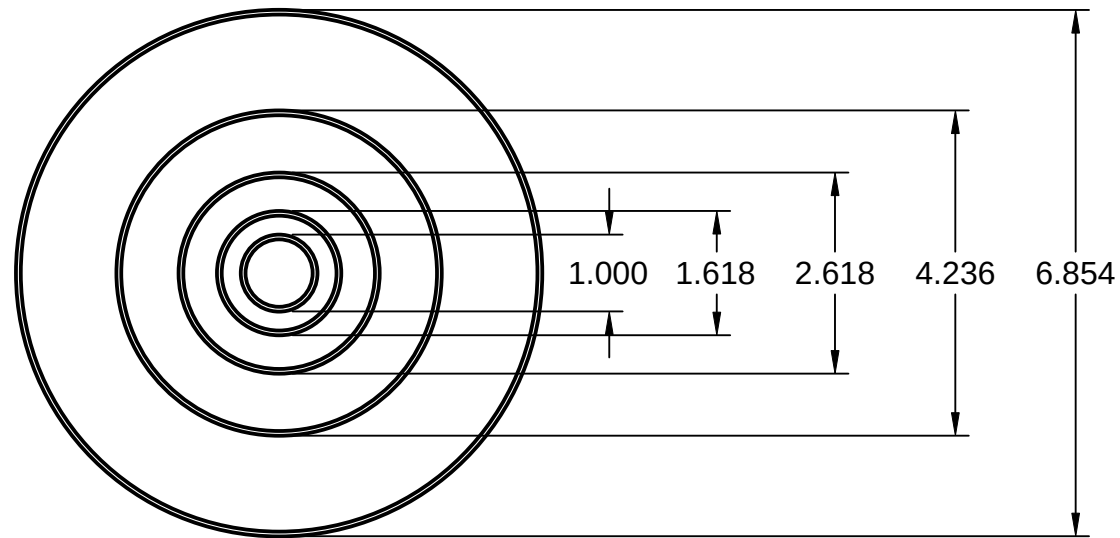

All Units in Inches

PROJECT

Wave Articulation Matrix

TITLE

**1" Diameter Primary
Assembled**

SCALE 1:2.5

SHEET 2/3

#	Diameter	Length	Circumference
A	1.000	3.142	13.308
B	1.618	5.083	8.225
C	2.618	8.225	5.083
D	4.236	13.308	3.142
E	6.854	21.533	1.942

PROJECT	
Wave Articulation Matrix	
TITLE	
1" Diameter Primary Table	
SCALE	SHEET 3/3

All Units in Inches