

A

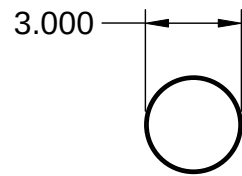

B

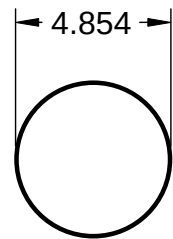

C

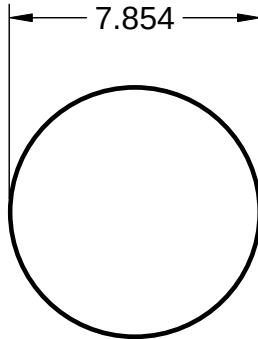

D

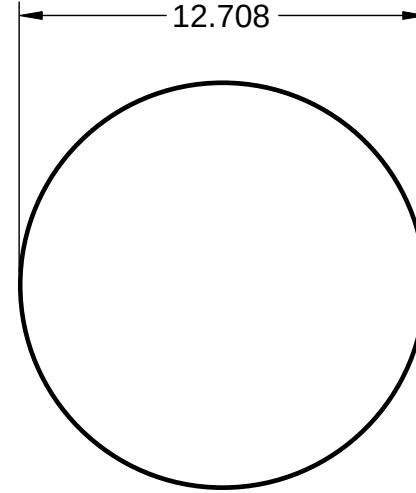

E

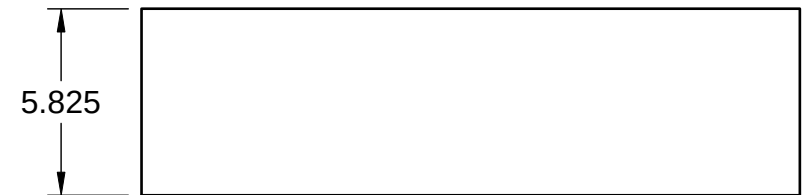
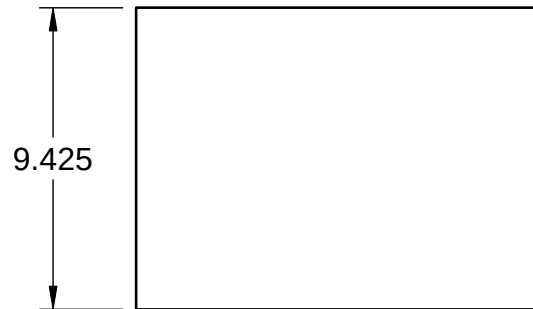
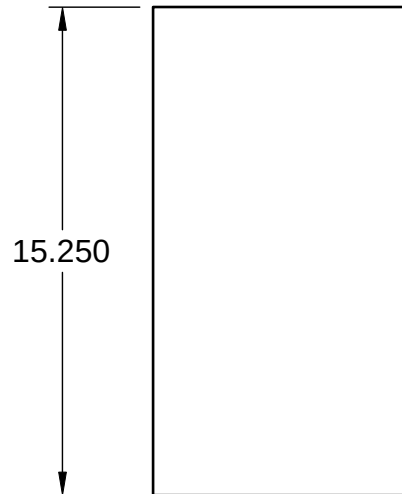
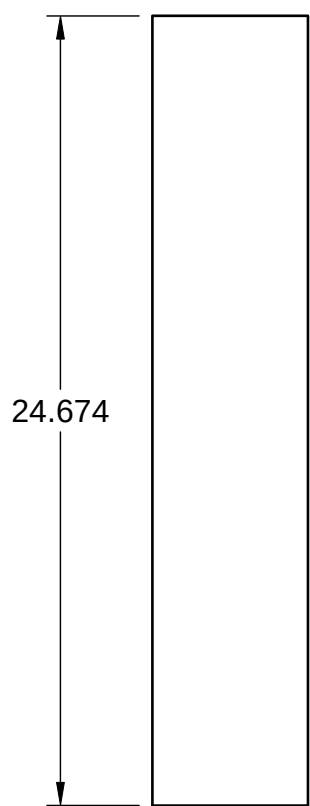
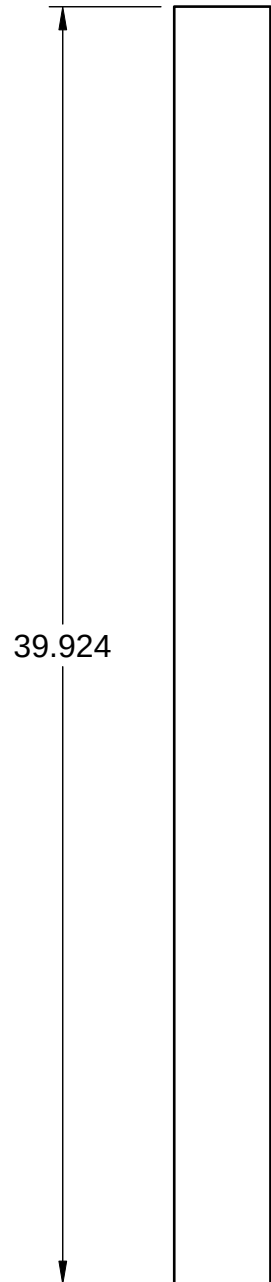
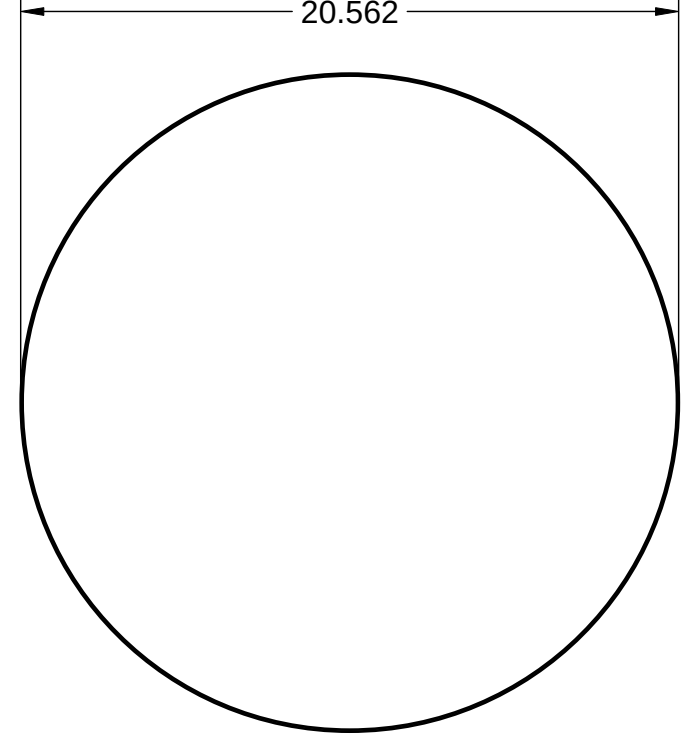

All Units in Inches

PROJECT

Wave Articulation Matrix

TITLE

3" Diameter Primary
Parts

SCALE 1:6

SHEET 1/3

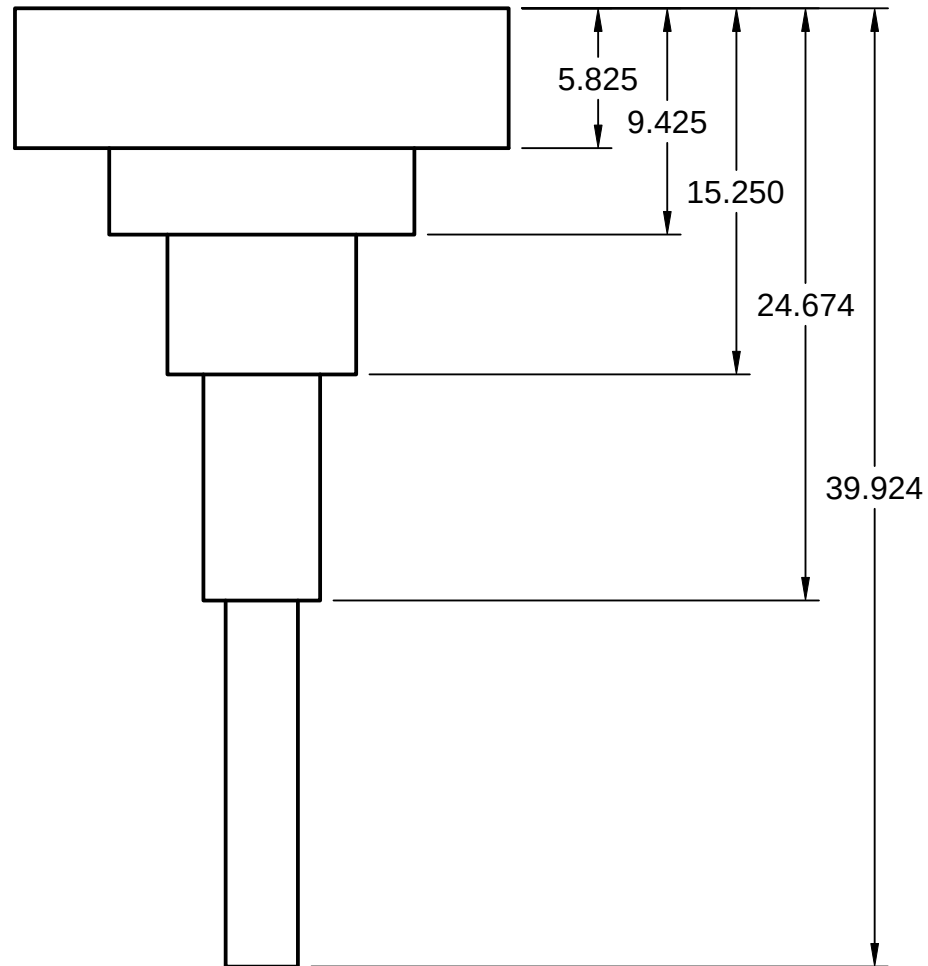
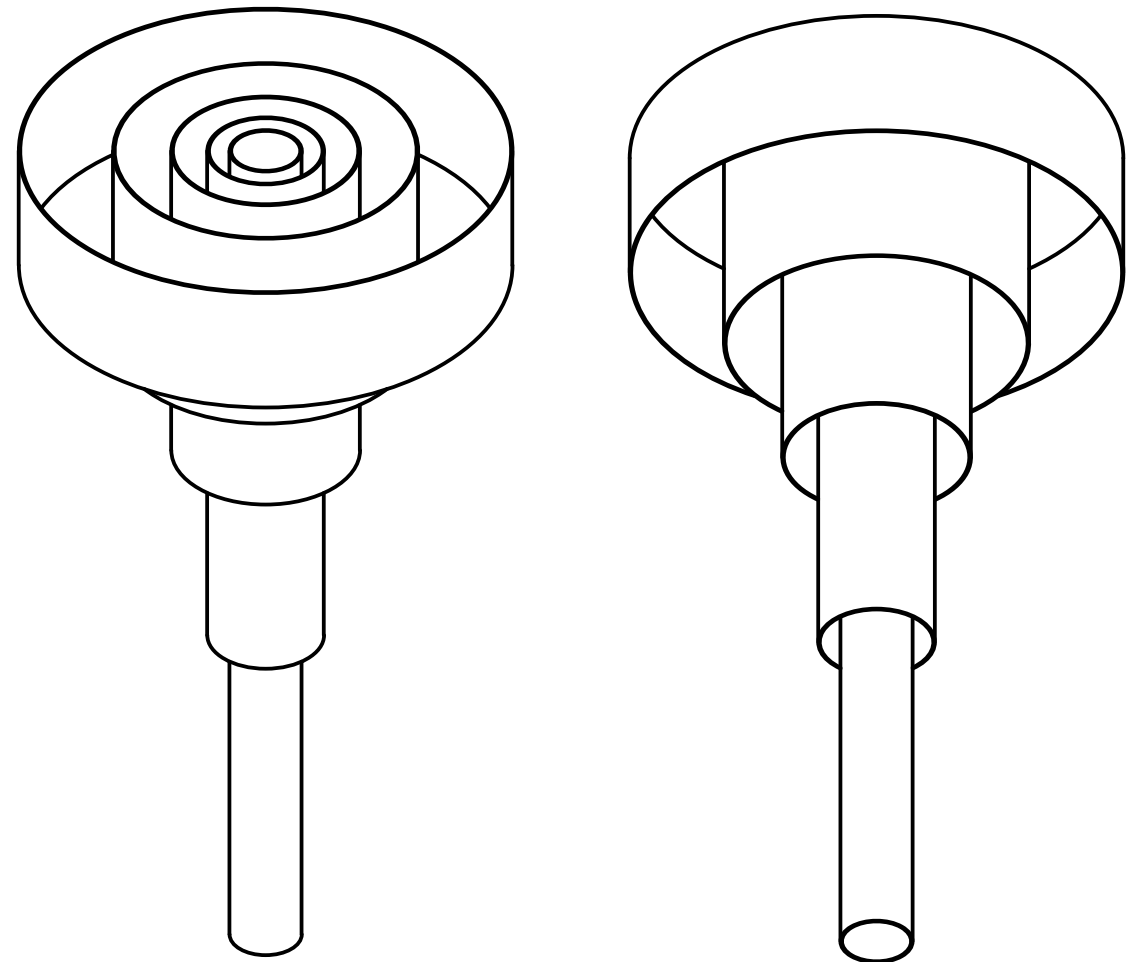
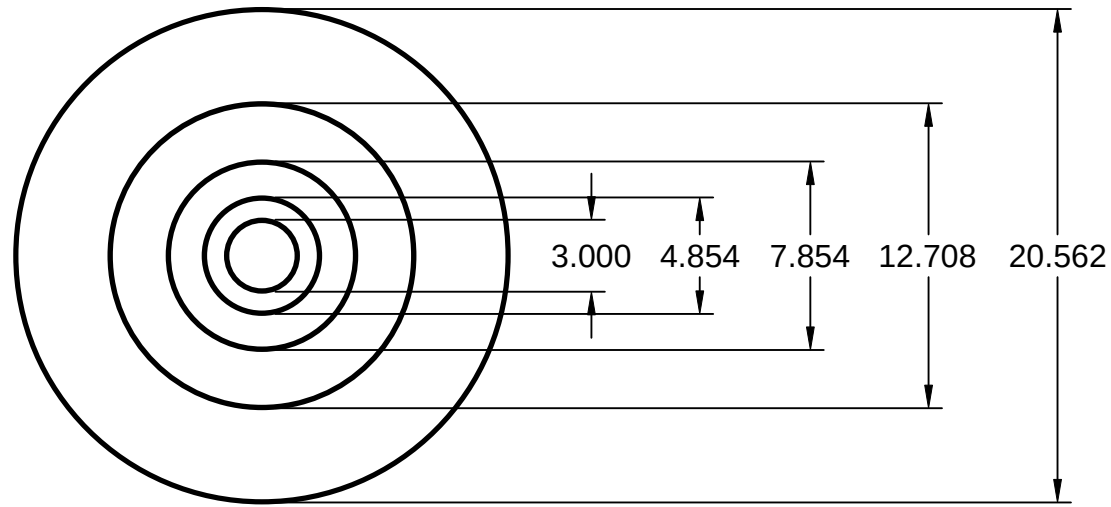

All Units in Inches

PROJECT	
Wave Articulation Matrix	
TITLE	
3" Diameter Primary Assembled	
SCALE 1:8	SHEET 2/3

#	Diameter	Length	Circumference
A	3.000	39.924	9.425
B	4.854	24.674	15.250
C	7.854	15.250	24.674
D	12.708	9.425	39.924
E	20.562	5.825	64.598

PROJECT

Wave Articulation Matrix

TITLE

**3" Diameter Primary
Table**

SCALE

SHEET 3/3

All Units in Inches